



Shenzhen Shumatt Technology Co., Ltd

**095030-7043 Injector Valve Stem G2 Series Technical File**

**SKU: G1F10950307043**



## 095030-7043 Injector Valve Stem G2 Series Technical File

### Content

1. 095030-7043 Injector Valve Stem Introduction .....	2
1.1. 095030-7043 Injector Valve Stem Basic Information .....	2
1.2. 095030-7043 Injector Valve Stem Common Part Number .....	2
1.3. 095030-7043 Injector Valve Stem Parameter .....	2
1.4. 095030-7043 Injector Valve Stem Specifications and Dimensions .....	2
1.5. 095030-7043 Injector Valve Stem Quality Control .....	3
1.6. 095030-7043 Injector Valve Stem Customized Service .....	3
1.7. 095030-7043 Injector Valve Stem Package List&Size .....	4
1.8. 095030-7043 Injector Valve Stem Testing Standard and Certificate .....	5
1.9. 095030-7043 Injector Valve Stem Warranty Description .....	6
2. 095030-7043 Injector Valve Stem Technical Support .....	7
2.1. 095030-7043 Injector Valve Stem Measuring Tools .....	7
2.2. 095030-7043 Injector Valve Stem Measuring Steps .....	8
2.3. 095030-7043 Injector Valve Stem Installation Precautions .....	8
2.4. Reasons For 095030-7043 Injector Valve Stem Not Working Normally .....	9
2.5. Causes of 095030-7043 Injector Valve Stem Being Damaged .....	9
2.6. 095030-7043 Injector Valve Stem Storage Standard .....	10
2.7. 095030-7043 Injector Valve Stem Technical Support Obtaining Methods .....	11
3. 095030-7043 Injector Valve Stem Purchase and Delivery .....	11
3.1. 095030-7043 Injector Valve Stem Purchase Payment Term .....	11
3.2. 095030-7043 Injector Valve Stem Main Sales Markets .....	11
3.3. 095030-7043 Injector Valve Stem Declaration Requirements .....	11
3.4. 095030-7043 Injector Valve Stem Shipping Ways .....	11
3.5. 095030-7043 Injector Valve Stem Lead time .....	11
3.6. 095030-7043 Injector Valve Stem Logistics Time for Destination Out of China's Areas .....	12
3.7. 095030-7043 Injector Valve Stem Packing .....	12
4. Company Information .....	14
4.1. Company Introduction .....	14
4.2. Sale-men Contact Information .....	15
5. Copyright Statement .....	15

## 095030-7043 Injector Valve Stem G2 Series Technical File

### 1. 095030-7043 Injector Valve Stem Introduction

#### 1.1. 095030-7043 Injector Valve Stem Basic Information

Title	095030-7043 Injector Valve Stem China Made New
SKU	G1F10950307043

#### 1.2. 095030-7043 Injector Valve Stem Common Part Number

##### (1) Injector Valve Stem Applicable Injector Model

Injector Valve Stem Part Number	OE Number
095000-652#	23670-E0091
095000-651#	23670-E0080

##### (2) Injector Valve Stem Matching Information

Vehicle Brand	Car Model	Engine Model	Production Date
HINO	TRUCK	N04C-TR	0609
HINO	TRUCK	N04C-TS	0609
HINO	TRUCK	N04C-TT	0609
TOYOTA	DYNA	N04C-TT	0609

##### (3) Injector Valve Stem Part Number Common Writing

095000-6130, 095000-6131, 095000-6132, 095000-6133, 095000-6134, 095000-6135, 095000-6136, 095000-6137, 095000-6138, 095000-6139, 095000-613#, D28001801, 095030-114#, 095030-1140, 095030-1141, 095030-1142, 095030-7043, 095030-1144, 095030-1145, 095030-1146, 095030-1147, 095030-1148, 095030-1149, 8-97376270-3, 8-973762703, 897376270-3, 8973762703

#### 1.3. 095030-7043 Injector Valve Stem Parameter

Adaptation System: **Common Rail System**

Injector Valve Stem Series: **G2 Series**

Injector Valve Stem Size: **L70.93mm\*Φ4.3mm**

#### 1.4. 095030-7043 Injector Valve Stem Specifications and Dimensions

Injector Valve Stem Size: **14\*1\*1=25 cm<sup>3</sup> (L\*W\*H=V)**

Single Injector Valve Stem Weight: **20g**

Injector Valve Stem Weight With Packaging: **25g**

Injector Valve Stem Quality: **China Made New**

Injector Valve Stem Package Size: **14\* 1cm \*1m =14<sup>3</sup> (L\*W\*H=V)**

Injector Valve Stem Type: **High Pressure Common Rail Injector Valve Stem**

Injector Valve Stem MOQ: **1pcs**



**1.5. 095030-7043 Injector Valve Stem Quality Control**

**(1) Injector Valve Stem Testing**

All parts of the Injector valve stem have undergone electrical characteristics testing, precision testing, high temperature testing, low temperature testing, withstand pressure testing, leakage testing, durability testing, and various working conditions testing.

**(2) Injector Valve Stem Installation**



The injector valve stem production and installation process is quality controlled. Our company strictly follows the standard product installation data and product installation steps for installation, such as injector stroke test, injector solenoid valve tightening torque, injector nozzle tightening torque.

**(3) Injector Valve Stem Inspection**

The factory inspection of the injector valve stem has undergone three inspections: full inspection, random inspection, and batch inspection. Different brands of test benches are used to test the same injector valve stem for more than three times for factory inspection, and the injector valve stem installation testing environment are progressed in dust-free workshop.

**1.6. 095030-7043 Injector Valve Stem Customized Service**

**(1) Injector Valve Stem Customized Service Coverage:** Meet OEM manufacturers' customization needs for shell engraving, logo engraving, injector valve stem internal packaging, injector valve stem external packaging and labels, etc.

No.	1	2
Image		
Name	Injector Valve Stem Engraving	Injector Valve Stem Packing&Label

**(2) Injector Valve Stem Customized Service Requirements:**

The purchase of customized **injector valve stem** is no less than **10 pieces**.



The purchase of customized **injector valve stem boxes** is no less than **1000 pieces**.

▲ **When the customized products involve the need of specify logo, the OEM manufacturer is asked to provide trademark authorization and the sample of logo image file.**

▲ **Once the customized injector valve stem is sold, it can't be returned or exchanged if there is no quality problems.**

1.7. 095030-7043 Injector Valve Stem Package List&Size

(1) Injector Valve Stem Spare Parts List

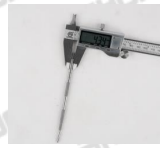
No.	1	2	3
Reference Image			
Name	Injector Valve Stem	Injector Valve Stem Length	Injector Valve Stem diameter
Description	/	L70.93mm	Φ 4.3mm

▲ Minors are forbidden to use the injector assembly, O-ring, nozzle protective cover, injector house protective cover, oil return protective cover, VCI anti-rust bag, and air bubble bag to avoid personal injury.

▲ O-ring and washer shim are disposable installation accessories, and need to be replaced for re-installation.

▲ The nozzle protective cover, the injector house protective cover, and the oil return protective cover are recyclable accessories that can be reused.

▲ VCI anti-rust bags and bubble bags are non-degradable materials. Please dispose of them properly after using.

▲ The injector and the installation parts should be coated with appropriate sealing oil during installation.

(2) Injector Valve Stem Package Size



Pic No.1

No.	Name	Injector Valve Stem Package Size (cm)
1	Injector Valve Stem Package	14*1*1

### 1.8. 095030-7043 Injector Valve Stem Testing Standard and Certificate

We can provide the factory quality inspection test report of each injector valve stem to ensure that each injector valve stem delivered meets the engine performance indicators.



BOTEN		测试报告		4.05.2019 10:42:59	
企业名称: _____					
电话: _____		地址: _____			
传真: _____		检测人: _____			
客户地址: _____		检测单位: _____			
电话: _____		客户姓名: _____			
检测描述: _____					
检测名称: 检测					
型号-零件号: _____					
检测内容: _____					
<b>检测结果</b>					
检测编号: C095030-7043					
	检测项目	检测结果	标准值	合格/不合格	
	LEAK TEST:	0E	0	0.5	0.0-1.0 E
	End:	0E	0	15.7	0.0-20.0 E
	WFRM:	0E	0.0	0.0	0.0-0.5 E
	Max:	0.15	0.15	0.0	0.0-0.5 E
	TL:	0.4	0.4	0.0	0.0-0.5 E
	LL:	14.1	14.1	0.0	0.0-0.5 E
	VE:	0.7	0.7	0.0	0.0-0.5 E
<input type="checkbox"/> 检测前 <input type="checkbox"/> 检测后					

Pic No.2

### 1.9. 095030-7043 Injector Valve Stem Warranty Description

#### (1) Product Warranty Conditions and Instructions

It is necessary to provide pictures, videos, or test reports detected by the injector valve stem inspection equipment as evidence to feed back to the salesman when the injector valve stem is abnormal during using.

Abnormal conditions are properly explained such as: 1.Smoke, 2. Engine shake, 3. Difficulty starting the engine, 4. Engine noise, 5. Oil leakage etc.

#### (2) Injector Valve Stem Warranty Coverage

Within 15 days after customer receives the [095030-7043](#) injector valve stem, if there is a performance failure and the product has no appearance damage, customer can choose to replace it or repair it;

If the [095030-7043](#) injector valve stem has performance problems during the warranty period (6-12 months), and it is confirmed that it is product's problems after testing, you can contact our salesmen to replace the same model or a reworked product with the same performance for free;

If the injector valve stem has obvious scratches, it can only be repaired and it will be returned as it is if the product is confirmed to be fault-free.

**▲ Tips: For products not covered by warranty, our company can provide paid maintenance services. For products after paid repaired, the same performance problem will have a free warranty period within 3 months from the date of repairing.**

**(3) injector valve stem Out of Warranty Coverage**

- ① The warranty period has expired.
- ② Injector valve stem failure caused by high temperature, high pressure, humidity, rain and snow, saline-alkali land, earthquake, and used in abnormal environment.
- ③ Customer disassembles or repairs the injector valve stem personally resulting in damage to the injector valve stem.
- ④ Injector valve stem damage caused by man-made reasons (throwing, strong magnetic field magnetization, set fire).
- ⑤ Injector valve stem failure or injector valve stem damage caused by non-injector valve stem design, technology, manufacturing, quality and other issues.
- ⑥ Injector valve stem failure due to system pressure exceeding system approved pressure.
- ⑦ Injector valve stem failure caused by system voltage exceeding approved voltage.
- ⑧ Injector valve stem failure caused by impurities (water, lead, aluminum powder, iron powder, sulfide) in the system fuel exceeding the standard requirements.
- ⑨ Injector valve stem failure caused by not installing according to the tightening torque specified in the vehicle engine maintenance manual (the tightening torque is too large or too small).
- ⑩ Injector valve stem failure caused by not following the installation angle specified in the vehicle engine maintenance manual.
- 11 Injector valve stem failure caused by not following the cleaning requirements specified in the vehicle engine maintenance manual.
- 12 Injector valve stem failure caused by failure to replace consumable parts as specified in the vehicle engine maintenance manual.
- 13 Injector valve stem failure caused by not complying with the intake system fit clearance and exhaust system fit clearance requirements specified in the vehicle engine maintenance manual.
- 14 Failure to replace the consumable parts and the fitting clearance of the oil inlet system pipeline and the injector valve stem connection in accordance with the fuel intake system specified in the vehicle engine maintenance manual.

**2. 095030-7043 Injector Valve Stem Technical Support****2.1. 095030-7043 Injector Valve Stem Measuring Tools**



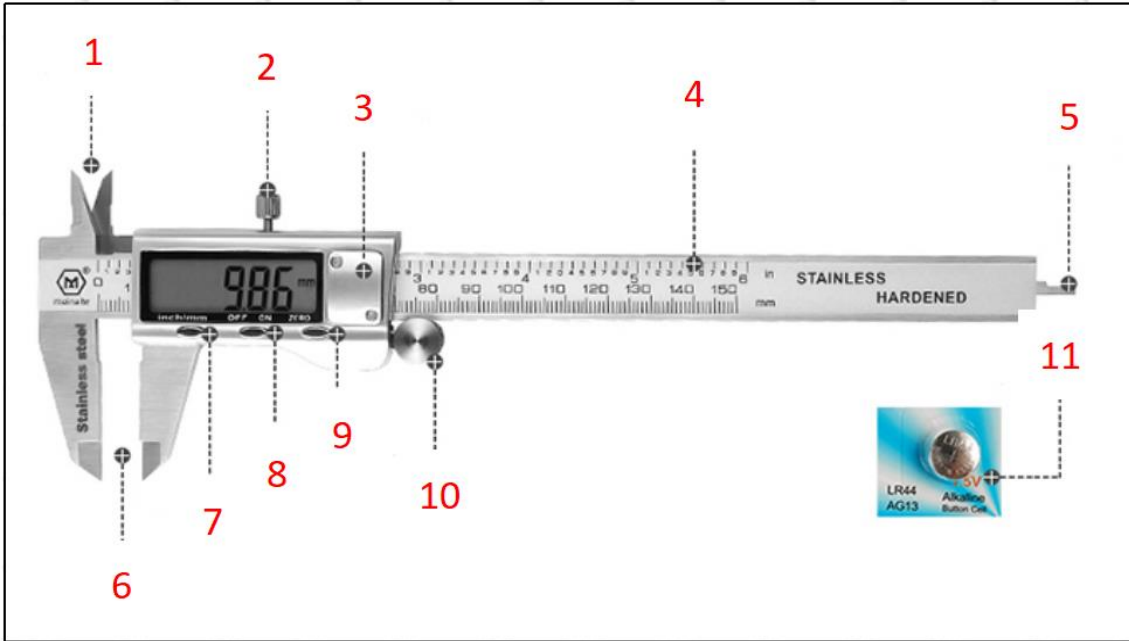

Pic No.3

1. Inner diameter measuring claw	7. inch/mm metric and inch conversion button
2. Limit screw	8. OFF/ON power button
3. Battery installation place	9. ZERO button
4. Ruler body	10. Push roller
5. depth measurement	11. Button battery
6. depth measurement	/

### 2.2. 095030-7043 Injector Valve Stem Measuring Steps

No.	1	2
Image		
Description	Step 1: Choose caliper: CRT085	Step 2: First open the caliper (OFF/ON), then return the display (ZERO) to zero ▲The caliper must be adjusted to zero before measuring.

### 2.3. 095030-7043 Injector Valve Stem Installation Precautions

- (1) The replacement of the injector valve stem must strictly follow the electrical system, the approved pressure of the low-pressure fuel intake system, the approved pressure of the high-pressure fuel circuit system, and fuel system replacement consumables requirements (including the low-pressure

fuel circuit system filter and the high-pressure fuel circuit) specified in the vehicle engine maintenance manual.

- (2) Replacement of wearing parts of the fuel system, cleaning requirements for the connection between the fuel system and the injector valve stem, the fitting clearance of the injector valve stem connection, the installation angle and tightening torque of the injector valve stem, the fitting clearance of the intake system, and the fitting clearance of the exhaust system to ensure the service life of the engine and the normal operation of the injector valve stem.
- (3) When installing the injector valve stem on the engine, it is necessary to clean the engine block, cylinder head and other parts connected to the injector valve stem, and ensure that there is no dust, carbon deposits, water, rust spots, etc.
- (4) Before installing, check whether the injector valve stem nozzle gasket has been replaced and installed on the injector valve stem.
- (5) When installing the injector valve stem, apply lubricant between the injector valve stem, fuel nozzle sealing gasket and O-ring.
- (6) Failure to replace the gasket with a new one may result in: deformation of the tight cap of nozzle, deformation of nozzle, deformation of nozzle orifice, oil leakage and air leakage, which will cause serious damage to the injector valve stem and nozzle to break and cause damage to the engine.
- (7) When installing the injector valve stem on the engine, please carefully check the components related to the installation of the injector valve stem, such as the injector valve stem pressure plate, screw, injector valve stem rod and other accessories are not deformed, and install it in strict accordance with the operation steps of the engine maintenance manual.
- (8) It is forbidden to operate the bare injector valve stem for a long time in an environment with serious dust pollution and corrosion to iron products.
- (9) It is forbidden to operate the bare injector valve stem for a long time in a strong magnetic field environment.

#### **2.4. Reasons For 095030-7043 Injector Valve Stem Not Working Normally**

- (1) There is air in the oil circuit of the engine fuel system.
- (2) Vehicle oil pump oil supply system is not normal.
- (3) Engine common rail system oil leakage or pressure limiting valve is damaged.
- (4) There is a short circuit, cutting out and poor contact in the wiring harness connected to the injector valve stem of the vehicle.
- (5) The long-term placement of the injector valve stem causes the anti-rust oil to solidify, and the internal components are stuck or the oil holes are blocked.

▲ Before installing, carefully check whether other components in the common rail system except the injector valve stem are damaged so as to prevent the injector valve stem from not working properly after being replaced.

#### **2.5. Causes of 095030-7043 Injector Valve Stem Being Damaged**

- (1) Failure to operate correctly according to the engine maintenance manual during disassembly and assembly resulted in damage to the injector valve stem.
- (2) The fuel used for the vehicle does not meet the standard, causing damage to the injector valve stem, such as: the water content in the fuel oil exceeds the standard, iron powder, aluminum powder,

sulfide impurities exceed the standard, etc.

- (3) The engine is not regularly maintained according to the engine maintenance manual (please refer to the vehicle maintenance manual for the maintenance mileage). For example, failure to replace the lubricating oil of the engine system for a long time will cause abnormal wear of the engine, excessive exhaust gas volume or a large amount of carbon deposits inside the engine. The filter is not replaced during maintenance or the replaced filter cannot reach the original filter standard. All above reasons can cause damage to the injector valve stem.
- (4) The abrasion of the oil pump produces iron powder and aluminum powder enter the injector valve stem and cause damage to the injector valve stem.
- (5) The deformation and abrasion of fuel tank result in iron powder or aluminum powder entering the injector valve stem and causing damage to the injector valve stem.
- (6) The injector valve stem is damaged due to replacement or adjustment of the relevant parts of the injector valve stem. For example, the valve clearance does not meet the standard after the engine is repaired, the replacement or modification of the wiring harness connected to the injector valve stem fails to meet the original standard.
- (7) The engine is overheated and overloaded for a long time working results in damage to the injector valve stem.
- (8) The injector valve stem will be damaged naturally at the end of its working life.
- (9) The injector valve stem is magnetized (injector valve stem parts' magnetic exceeded) causing the injector valve stem to not work properly.

▲ **Before replacing the injector valve stem, please check the engine parts carefully according to the engine maintenance manual to avoid the injector valve stem being damaged again after replacement.**

## 2.6. 095030-7043 Injector Valve Stem Storage Standard

### (1) Choose a Suitable Storage Place

The warehouse and cargo yard where the injector valve stems are stored should be kept clean and dry, and away from the factory buildings that generate harmful gases and dust; do not mix with acid, alkali, salt and other substances; the storage place should have a good drainage system; the cargo yard should be flattened with gravel or furnace ash etc. to enhance the water permeability of the surface layer to keep the reservoir area dry.

### (2) Strict Requirements of Warehousing

Strict inspections should be carried out when the injector valve stems are put into storage, the surface cleaning work should be done well to remove water traces, oil stains, ash and other dirt, remove the rust and do anti-rust treatment in time. Packaged injector valve stems must be protected from damage.

### (3) Keep The Warehouse Dry And Preventing Moisture

The relative humidity is usually below 70% for the injector valve stems placed in the room, and the corrosion of the injector valve stems is significantly reduced.

Injector valve stems must be stored in the warehouse, and they are forbidden to store in the same warehouse with commodities with high water content.

### (4) Stack Properly

After the injector valve stem is exposed to rain, the corrosion rate will increase significantly. The purpose of sealing is to isolate the injector valve stem from rainwater and humid air, so the warehouse window should be checked in time to avoid rainwater entering the warehouse



If the injector valve stem package is damaged, it should be repaired or replaced; when the package is damp, the packaging material should be dried; if the original anti-corrosion and oil applied at the factory is found to be damaged or dried up, it should be cleaned and re-applied oil in time.

- ▲ It is forbidden to leave the injector valve stem exposed in the air for a long time.
- ▲ It is forbidden to store acid, alkali, salt and other substances together with the injector valve stem.
- ▲ The unpacked injector valve stem must be rust-proof during secondary storage.

## 2.7. 095030-7043 Injector Valve Stem Technical Support Obtaining Methods

- (1) Injector Valve Stem Technical File, visit <http://shumatt.com> to get the technical file.
- (2) Injector Valve Stem Technical Videos

**Facebook:** Visit <https://www.facebook.com/hison.li> to get the technical videos, constantly follow can get more information.

**YouTube:** [https://www.youtube.com/channel/UCByvYBx7VjV\\_mAfxh\\_Hu-aw](https://www.youtube.com/channel/UCByvYBx7VjV_mAfxh_Hu-aw) to get the technical videos, constantly follow can get more information.

**Shumatt:** Visit <http://shumatt.com> to get the technical videos.

- (3) Injector Valve Stem Information Query Software  
TruckBook Parts EPC APP, Android/Apple App Store download and install, visit <http://shumatt.com> to get the download and installation tutorial.
- (4) Search the injector valve stem test data through TruckBook Parts EPC APP.

## 3. 095030-7043 Injector Valve Stem Purchase and Delivery

### 3.1. 095030-7043 Injector Valve Stem Purchase Payment Term

**Payment Terms:** T/T, PayPal, Alipay, WeChat

- ▲ Please contact our salesmen for specific payment information.

### 3.2. 095030-7043 Injector Valve Stem Main Sales Markets

**Injector Valve Stem Main Sales Markets:** Asia, Europe, North America, South America, Africa etc.

### 3.3. 095030-7043 Injector Valve Stem Declaration Requirements

Shumatt can assist customers to provide the following documents for import customs clearance: contract, invoice, packing list, bill of lading, insurance policy, certificate of origin, etc.

### 3.4. 095030-7043 Injector Valve Stem Shipping Ways

**Destination in China Areas:** SF Express, Debon Express, the corresponding logistics company can be provided according to customer requirements in special cases.

**Destinations Out of China's Areas:** DHL, UPS, FedEx, TNT air, ocean or other shipping methods required by customers.

### 3.5. 095030-7043 Injector Valve Stem Lead time

**Lead time:** Send out within 3 – 7 working days after receiving payment (Except for special products and special cases) .

**3.6. 095030-7043 Injector Valve Stem Logistics Time for Destination Out of China's Areas**

**DHL Logistics Time :**

Country or Region of Departure	Hong Kong, China	Other Countries or Regions of Asia	Australia and New Zealand	Europe	America	Other Countries
China's Mainland	7 Days	7 Days	8 Days	8 Days	8-12 Days	7-10 Days

**UPS Logistics Time: Country or Region of Departure: China's Mainland**

Country of Destination	Estimated Arrival Time	Country of Destination	Estimated Arrival Time	Country of Destination	Estimated Arrival Time
Japan	3 Days	UK	5-7Days	Egypt	5-7 Days
Turkey	5-7 Days	Singapore	3 Days	Switzerland	5-7 Days
Bahrain	5-7 Days	Latvia	7-10 Days	New Zealand	7-10 Days
Sri Lanka	5-7 Days	Thailand	3 Days	Austria	5-7 Days
Romania	5-7 Days	Vietnam	3-5 Days	Estonia	5-7 Days
Malaysia	3-5 Days	Israel	5-7 Days	Mexico	7-10 Days
France	5-7 Days	America	5-7 Days	United Arab Emirates	5-7 Days
Italy	5-7 Days	Netherlands	5-7 Days	Bengal	7-10 Days
Lebanon	5-7 Days	Philippine	3-5 Days	Greece	7-10 Days
South Korea	3 Days	Spain	5-7 Days	Myanmar	5-7 Days
Canada	5-7 Days	Germany	5-7 Days	Saudi Arabia	7-10 Days
Portugal	5-7 Days	Australia	5-7 Days	South Africa	7-10 Days
Denmark	5-7 Days	Belgium	5-7 Days	Ukraine	7-10 Days
India	7-10 Days	Qatar	7-10 Days	Poland	5-7 Days
Indonesia	3-5 Days	Morocco	7-10 Days	Pakistan	7-10 Days
Kuwait	7-10 Days	/	/	/	/

▲ The logistics time is for reference only , subjects are according to the actual arrival.

**3.7. 095030-7043 Injector Valve Stem Packing**

**Domestic Express Packaging:** Usually wrapped in waterproof scotch tape, such as picture No.4.

**International Express Packaging:** Wrapped with waterproof yellow tape after wrapping the black protective film, such as picture No. 5.

**Pallet Shipping:** Use fumigation free and recycling trays that meet export requirements, and use white wrapping protective film to wrap and bind with cable ties for the outside, such as picture No. 6, also, the products can be packaged according to customers' requirements.

- ▲ The packing tray is made of plastic and can be recycled.
- ▲ Transparent tape, yellow tape, black wrapping protective film, white wrapping protective film are non-degradable materials, please dispose of them properly.
- ▲ Minors are prohibited from using transparent tape, yellow tape, black wrapping protective film, and white wrapping protective film to avoid personal injury.



Pic No. 4

**Domestic Express Packaging:**

Wrapped with transparent tape

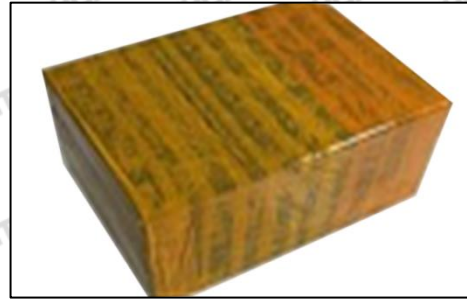

Pic No. 5

**International Express Packaging:**Wrapped with yellow tape after wrapping  
black protective film

Pic No. 6

**Pallet Shipping:** Use pallet that meet export requirements, and use white wrapping protective film to wrap and bind with cable ties



#### 4. Company Information



- Office Locations
- Global Exhibitions

Pic No. 7

#### 4.1. Company Introduction

**Chinese Name:** 深圳市舒马特科技有限公司

**English Name:** Shenzhen Shumatt Technology Co., Ltd

**Injector Valve Stem Manufacturer:** Shenzhen Shumatt Technology Co., Ltd

**Mob Phone/WeChat:** +86-13410541523

**HK Telephone:** +852-67653519

**Telephone:** +86-755-23215133

**Email:** [ruby@shumatt.com](mailto:ruby@shumatt.com)

**Website:** [www.shumatt.com](http://www.shumatt.com)

**Shenzhen Office:** 11-12, Floor 14, Building 13, Qinchengda Building, Exit A, Honglang North Subway Station, Bao'an District, Shenzhen, China Mainland

**Shenzhen Office:** Exit C, Qiao Touxu Metro Station, NO. 66 Chongqing Road, Fuhai Avenue, Bao'an District, Shenzhen, China Mainland

**Hong Kong Office:** Jianfa Street Industrial Zone, Tuen Mun, New Territories, Hong Kong, China

**After-sales Service Address:** Please contact our salesmen to obtain and provide the corresponding

Mob/Whatsapp: +86 13410541523

Email : [ruby@shumatt.com](mailto:ruby@shumatt.com)

© 2024 Shenzhen Shumatt Technology Co., Ltd

Tel: +8675523215133

Website : [www.shumatt.com](http://www.shumatt.com)

product maintenance reasons (Reference: [1.9. 095030-7043 Injector Valve Stem Nut Warranty Instructions](#))

#### 4.2. Sale-men Contact Information

No.	Name	WeChat/WhatsApp	Email	Facebook	YouTube
1	Ruby	+86-13410541523	<a href="mailto:ruby@shumatt.com">ruby@shumatt.com</a>	Hison Li	Hison Li
2	Ivy	+86-18025309821	<a href="mailto:sales@shumatt.com">sales@shumatt.com</a>	Ivy Shumatt	Shumatt IVY
3	Rebecca	+86-18025349821	<a href="mailto:sales01@shumatt.com">sales01@shumatt.com</a>	Rebecca Shumatt	ShumattRebecca
4	Janny	+86-18028749821	<a href="mailto:sales02@shumatt.com">sales02@shumatt.com</a>	Janny shumatt	Janny Shumatt
5	Sam	+86-13316859821	<a href="mailto:Sales8@shumatt.com">Sales8@shumatt.com</a>	Shumatt Sam	Sam Shumatt
6	Natalie	+86-18938945856	<a href="mailto:sales15@shumatt.com">sales15@shumatt.com</a>	Shumatt Natalie	Lin Natalie
7	Ada	+86-1342286353	<a href="mailto:sales5@shumatt.com">sales5@shumatt.com</a>	Shumatt Ada	Ada Shumatt
8	Hison Li	+86-18318811871	<a href="mailto:web@shumatt.com">web@shumatt.com</a>	Hison Li	Hison Li
9	Mecca	+86-18938948618	<a href="mailto:sales11@shumatt.com">sales11@shumatt.com</a>	Shumatt Mecca	Shumatt Mecca
10	Eric	+86 18319033618	<a href="mailto:sales3@shumatt.com">sales3@shumatt.com</a>		
11	Wayne ( Joaquín en español )	+86-13316959821	<a href="mailto:wayne@shumatt.com">wayne@shumatt.com</a>	shumattwayne	Wayne Shumatt
12	Sylvia	+86 18312499884	<a href="mailto:sales6@shumatt.com">sales6@shumatt.com</a>		

Visit <http://shumatt.com> to obtain the latest information of salesmen

PS: Shumatt's sales-men's emails are all end with [@shumatt.com](mailto:@shumatt.com)

#### 5. Copyright Statement

The copyright of any contents in this file "*095030-7043 Injector Valve Stem G2 Series Technical File*" (including but not limited to parameters, data, text, charts, images, sounds, videos, etc.) belongs to Shenzhen Shumatt Technology Co., Ltd. Without the prior written permission of Shenzhen Shumatt Technology Co., Ltd., you are not allowed to modify, duplicate, republish any content in "*095030-7043 Injector Valve Stem G2 Series Technical File*" in any way. At the same time, any conditions to spread, re-post, display the contents of "*095030-7043 Injector Valve Stem G2 Series Technical File*" should indicate the source of the quoted article, Shenzhen Shumatt Technology Co., Ltd. Any actions failure to follow above conditions violate the "*Copyright Law of the People's Republic of China*" and other laws and regulations as well as relevant provisions of international conventions.